











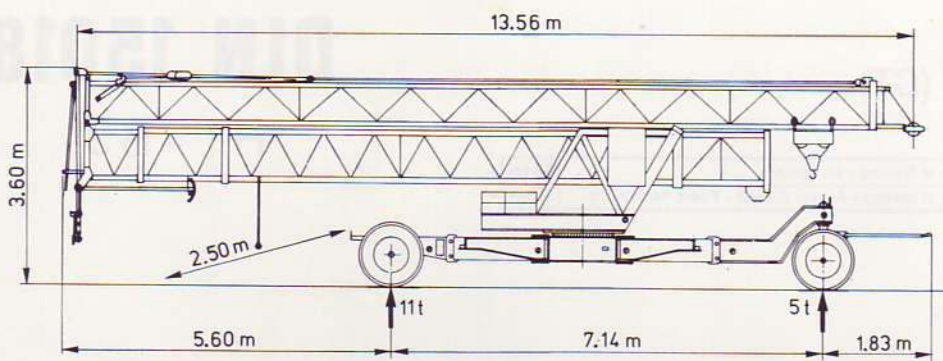

		m/min	kg			kW		
  9 kW		5	2000		30 m/min	1.5	 220 - 380V / 50 Hz 19 kVA	 35 kVA
		22.5	2000		0 → 1 rpm U/min	2.2		
		45	1000		25 m/min	2 x 1		
		5	2000		- zonder ballast - zonder transportstel - sans lest, sans train - without ballast - without towing axle - ohne Ballast, ohne Transportachse - sin lastre, ni tren de transporte	ca. 9600 kg		

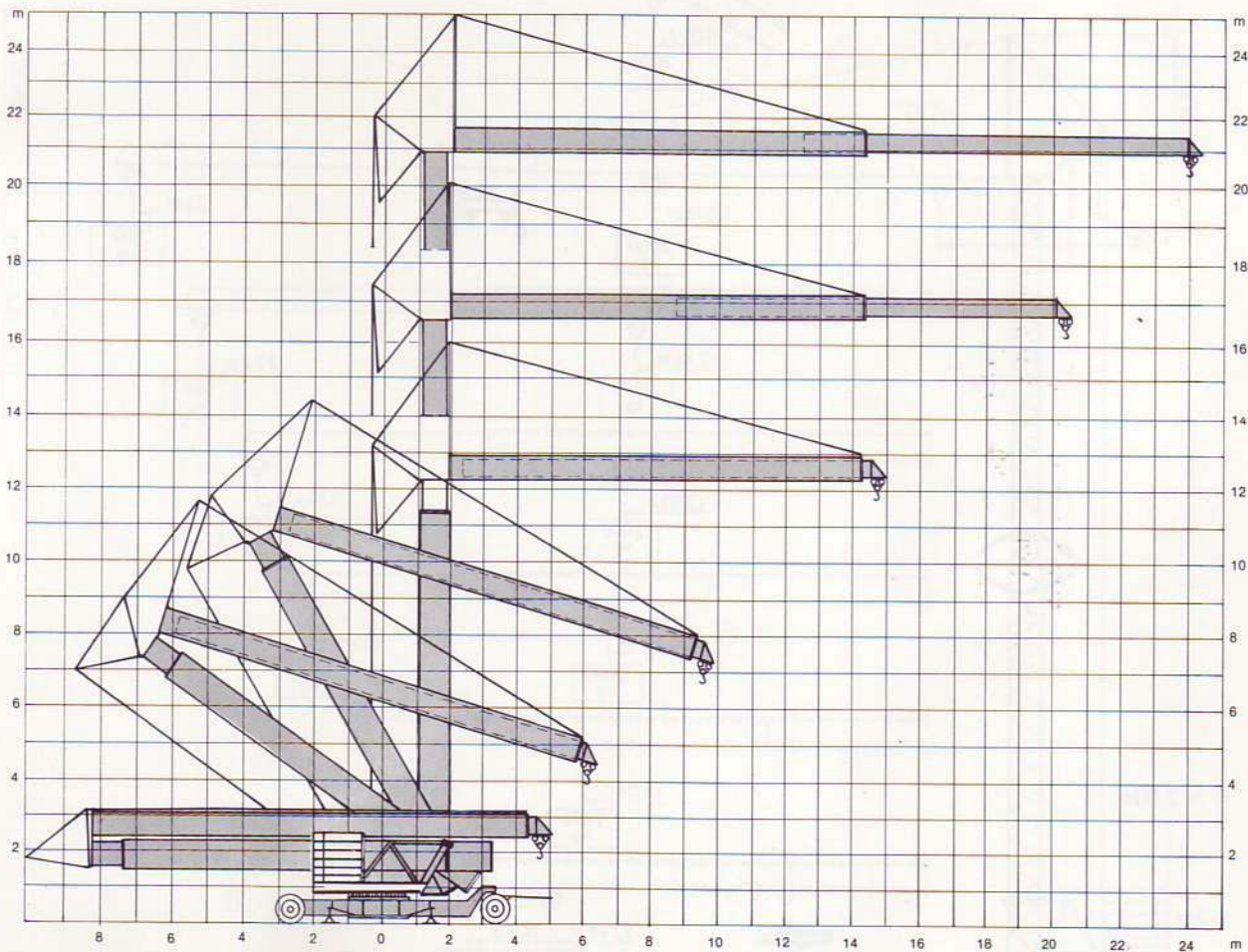

BMD
 BAUMASCHINENDIENST
HEIDELBERG

Am Taubenfeld 33 · D - 69123 Heidelberg
 Telefon: 0 62 21 / 8 35 80 · Telefax: 0 62 21 / 83 32 45
 www.bmd-heidelberg.de